



User Manual for 3-Channel 4-20 mA Current Node Model FAC0420-02

Description – Initialization – Technical Information

Node Technical Information

General	
Model	FAC0420-02
Dimension	Length × Height × Depth 10.4 cm × 2.4 cm × 9.4 cm
Weight	300 g
Working Temperature	-10 to 45 °C
Storage Temperature	-20 to 60 °C
Working Humidity	0 – 60%
Working Voltage	24 Volts
Mounting Brackets	2 holes at the top to be fixed on the wall
Guaranty	2 Years
Input/ Output	
Minimum Data Transmission Interval	500 ms
Type of Input	4 – 20 mA current
Number of Inputs	3
Output	RJ45 CANopen bus

Security Considerations

(Before using this product, please read the precautions)

Please carefully read this manual before using the product and pay full attention to the mentioned points to use the product correctly.

In this manual, safety measures are classified into two levels: “Warning  ” and “Caution  ”.

Warning 	Improper handling may lead to dangerous conditions and cause death or serious injury.
---	---

Caution 	Improper handling may lead to dangerous conditions and cause minor or moderate injury to persons or damage to property.
---	---

Follow the safety measures of both levels as they are very important for personal and system safety. Ensure that users read this manual and then keep it in a safe place for future reference.

Design Precautions

Warning

- Paying attention to the details of cabling and proper connection is one of the most important parts of installing Nodes, which directly affects the performance and efficiency of the network.
- Always use a consistent standard (T568A or T568B) at both ends of the cable to prevent connection issues.
- Mistakes in wiring during socket installation can lead to hardware damage to the Node or improper network performance.
- After installing the sockets, connect the cable to the Node. If the Node is not recognized or does not function properly, check the following:
 - Complete connection of the socket to the cable
 - Correct wiring arrangement
 - Use a network tester to identify potential cabling errors
 - If the above points are confirmed, test the relevant Node with a tested network cable at the data logger installation site to ensure the Node’s proper functioning.

- Avoid excessive bending or sudden pulling of cables while working with them, as this can damage the internal wires and reduce signal quality.

Caution 

- Do not bundle the RJ45 cable with the main circuit and power cables, and do not install them close to each other. Maintain a minimum distance of 100 mm (3.94 inches) between them. Failure to maintain this distance may cause interference due to noise.

Installation Precautions

Warning 

- Before installing the Node, ensure the quality of the used cable. The recommended cable by the manufacturer is RJ45 with CAT6. Failure to do so may cause product damage.
- To maintain the quality of the communication signal, it is mandatory to connect the shield of the RJ45 cable to shielded sockets. The body of the RJ45 female socket is grounded by default from the FIDAQUIRE device, and in the Node, all bodies are connected to each other - not to the circuit ground.

Caution 

- Use the 4-20 mA 3-channel Node in an environment that complies with the general specifications in this manual. Using this Node in any other operational environment may cause electric shock, fire, malfunction, or damage and reduce the quality of the module.
- Never directly touch the conductive part or electronic component of the 4-20 mA 3-channel Node. Doing so may cause malfunction or damage to the data logger.
- When installing the 4-20 mA 3-channel Node on the wall, carefully tighten the wall screws. Loose screws may cause the Node to fall and create a short circuit.
- Prevent foreign materials such as dust or wire fragments from entering the Node. These foreign materials may cause fire, malfunction, or damage.
- Do not disconnect and reconnect the Node while the FIDAQUIRE data logger is on. Doing so will damage the Node and the FIDAQUIRE data logger.

Wiring Precautions

Warning

- Before wiring, ensure the health and quality of all input and output cables. Failure to do so may cause product damage.
-

Caution

- Before connecting the RJ45 cable, ensure that the type of connector to be connected is correct. Connecting an incorrect connector or incorrect wiring will cause Node damage.
- When wall-mounting the Node, tighten the mounting bracket screws securely. Loose screws can cause the Node to fall and short circuit.
- Securely connect the RJ45 cable to the Node. Failure to do so may cause cable damage and improper device operation.
- Ensure that all incoming data cables connected to the Node are routed through a cable channel or secured with a cable tie. Failure to do so may result in accidental cable pulling, which can damage the Node and cables or cause module malfunction due to loosen connections.
- Handle RJ45 cables with care when disconnecting them from the Node. Pulling on the cables can lead to device malfunctions or damage to the Node or cable.

Operational safety measures

Warning

- Do not touch any conductive parts or electronic components of the data logger while the Node is transmitting data. Doing so may cause the Node to malfunction or fail.
-

Caution

- To avoid noise interference, keep all radio communication devices, including mobile phones, at least 25 centimeters away from the Node in all directions.
- Under no circumstances should the Node be reset while data is being transmitted.

Waste disposal precautions

Caution

- Dispose the 3-channel node output as industrial waste.
- Ensure nodes are segregated from other waste in accordance with local regulations. Dispose of nodes correctly at your local waste collection/recycling facility.

Contents of the box

Please verify that the box contents match the packing list. The following items should be included:

- A 3-channel 20-4 mA Node, model FAC0420-02 ¹
- Three input sockets
- A user manual.

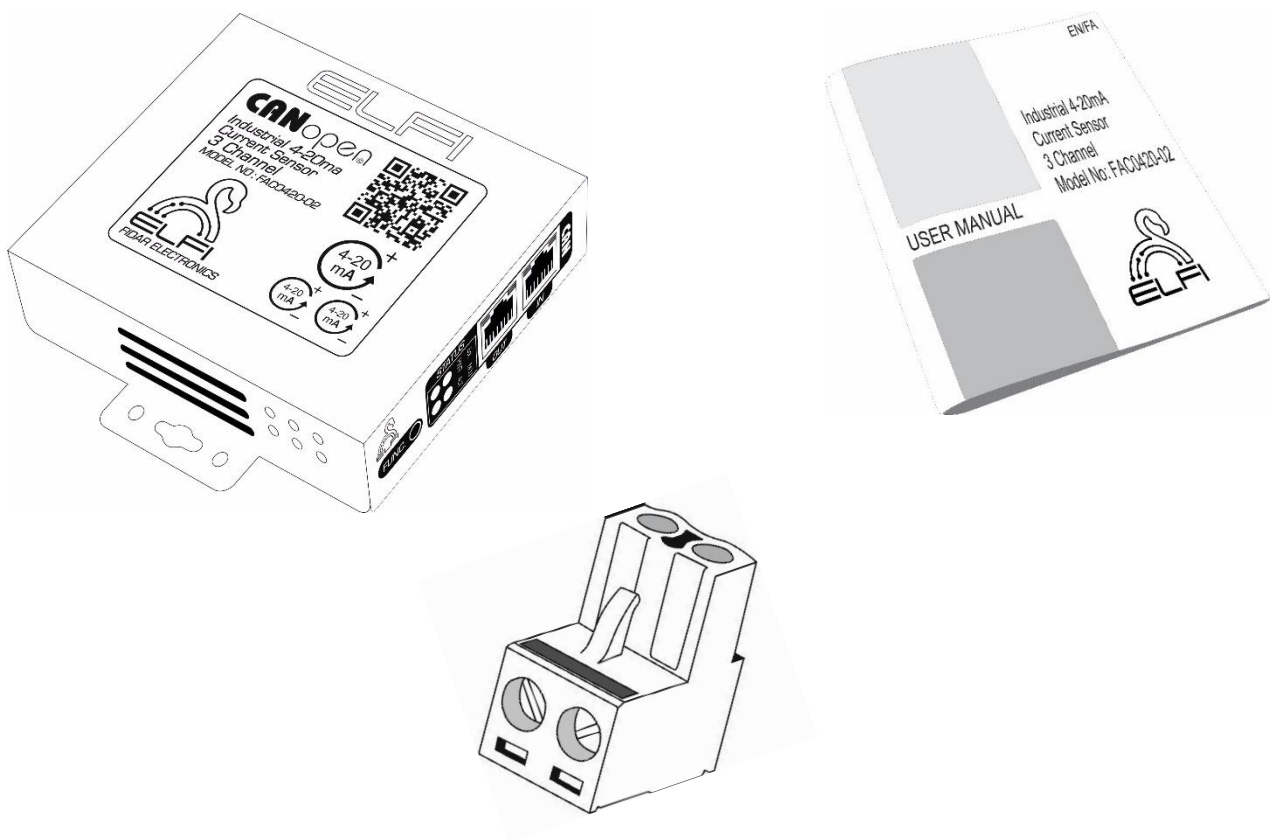

Figure 1: Contents of the box

1. Detailed dimensions of the device can be found on page 15 of the user manual.

Table of Contents

1. Initialization of the Node.....	9
2. Connecting Node to CANOpen Card.....	11
3. Calibration	12
4. Settings related to Node Software	13
5. Node Dimension	18
Contact us	19

1. Initialization of the Node

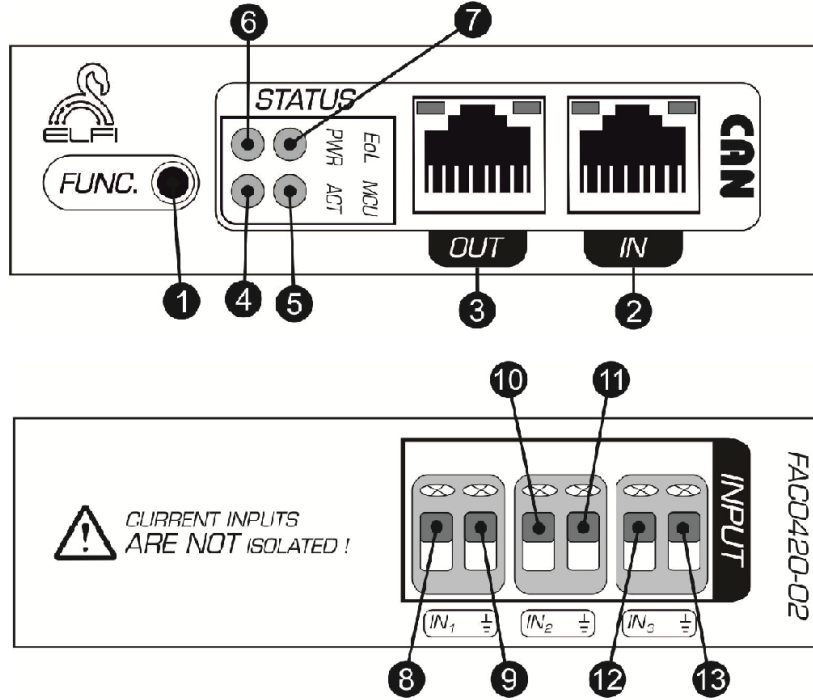

Figure 2: Side view of a 3-channel 20-4 milliampere node

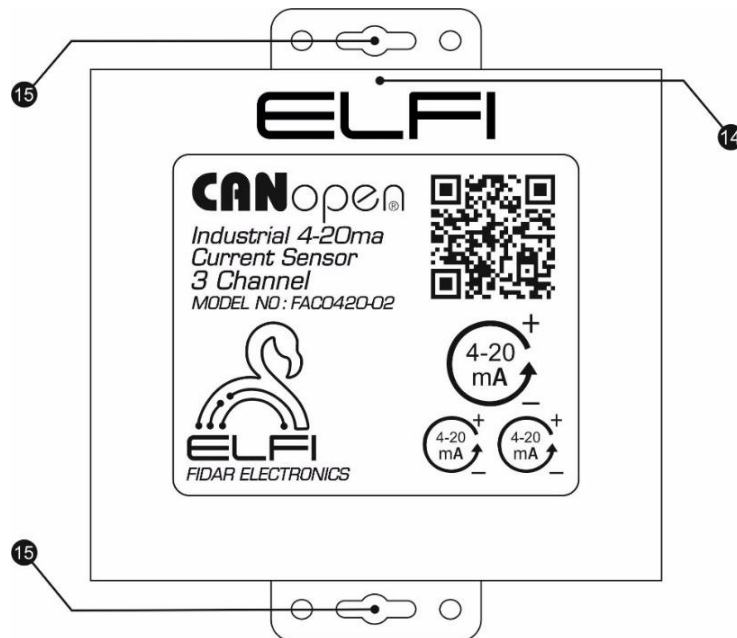

Figure 3: Front view of a 3-channel 20-4 milliampere node

Table 1: Information related to Node cover

Number	Name	Description
1	FUNC Key	To perform a calibration and factory reset procedure on the node
2	CAN Input	To connect the Node to the CANOpen card
3	CAN Output	To connect to subsequent Nodes
4	ACT LED	Provides information about the calibration of each channel. 1- Blinking once per second: Channel 1 calibration is in progress. 2- Blinking twice per second: Channel 2 calibration is in progress. 3- Blinking three times per second: Channel 3 calibration is in progress
5	MCU LED	The MCU LED indicates three different operating conditions: 1. Rapid blinking ¹ : The MCU is in a pre-operational state, undergoing initialization processes. 2. Steady blinking ² : The MCU is operational and running normally. 3. Calibration mode ³ : The MCU is performing calibration procedures.
6	POWER LED	Indicates Node's Power Connection
7	EOL LED	-Detection: Whether the Node is at the end of the bus path or not. - Illuminated EoL lamp: Indicates that the Node is at the end of the bus and automatically adds the End of Line resistance to the end of the path. - Unlit EoL lamp: Means that the Node is not at the end of the bus and automatically removes the End of Line resistance from the end of the path.
8	Node Positive Input	_____
9	Node Negative Input (Ground)	_____
10	Node Power Connection Display	If the Node's power is connected (on the CANOpen bus), the ELFI symbol will be displayed in green.
11	Wall Mounting Location	_____

1. Once per 200 ms
2. Once per second
3. Please refer to Section 3 for calibration settings.

2. Connecting Node to CANOpen Card

There are 2 ways to connect a Node to the CANOpen card:

1) If you are using only one Node to connect to the CANOpen card: Use a network cable to connect the CAN input port of the Node to the Main port of the FIDAQUIRE datalogger CANOpen card, and then perform the calibration process on the Node.

2) If you have more than one Node to connect to the CANOpen card: Use a network cable to connect the Main port of the FIDAQUIRE CANOpen card datalogger to the CAN input of the initial Node, and after activating the Node's hardware and software, connect the CAN output of the initial Node to the input of the next Node, and continue this process until the final Node.

Note: If the 4-20 mA Node is at the beginning or end of the bus during installation, as in the first case, simply connect the CAN input of the Node to the Main port of the CANOpen card datalogger.

Note: If the 4-20 mA Node is a middle Node, then as in the second case, connect the CAN input of the 4-20 mA Node to the CAN output of the next Node.

3. Calibration

To calibrate a Node or set its minimum and maximum values, follow these steps:

Step 1: Press and hold the Func button for 4 seconds. The Node will enter calibration mode and the MCU light will blink once per second. At this point, you can calibrate the zero point (4 mA) by entering the Low range value.

Step 2: Press the Func button again. The MCU light will blink twice per second. At this point, you should calibrate the 20 mA point by entering the High range value into the Node input. Finally, press the Func button to exit the Node from calibration mode.

Note: If multiple analog Nodes are connected to the CANOpen card, each Node must be calibrated separately. After ensuring that each Node is calibrated correctly, proceed to calibrate the subsequent Nodes.

4. Settings related to Node Software

To identify and initially activate the Node, after connecting the Node to the FIDAQUIRE CANOpen card datalogger, first enable the Active mode in the Node settings menu and then select the Initialize option (Figure 4).

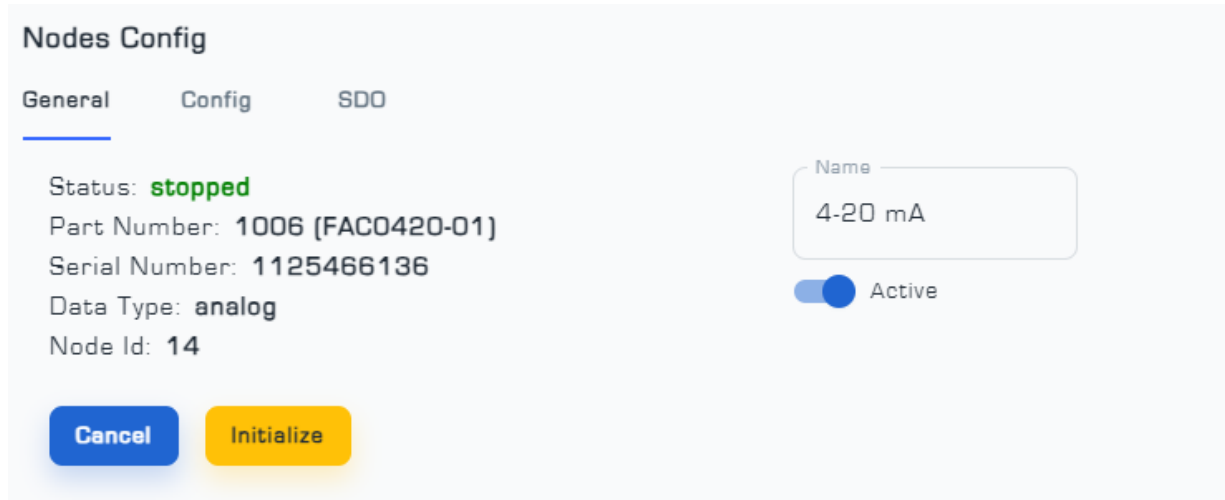

Figure 4: How to Initially Activate a Node

To apply the settings to the Node, click on it to display the Node settings page (Nodes Config) (Figure 5).

- The General menu includes information about the Node status, model, serial number, input data type, and Node number. You can also choose a custom name for the Node and even deactivate it if necessary (Figure 5).

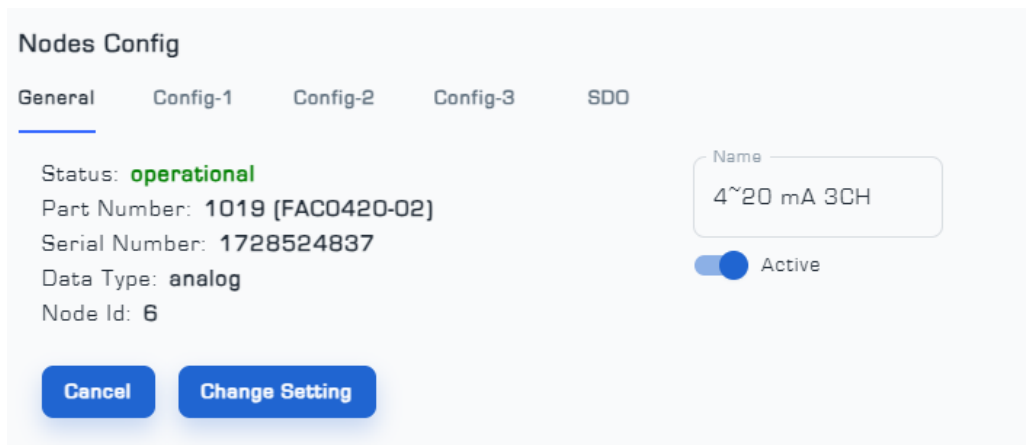

Figure 5: General Menu from Nodes Config Page

Note: Table 2 shows all possible Node status states

Figure 2: All Possible Node Status States

Status	Description
Offline	Network Cable or RJ45 disconnected
Operational	Node is sending data
Pre-Operational	Node is preparing to operate
Stop	Node deactivated

To remove a Node from the CANOpen card, first unplug the network cable from the Node to make it Offline. Then, in the General menu, select the Remove Node option.

Note: Please note that if the Node is completely removed from the card, its saved data will be completely deleted.

- In the Config menu of the 3-channel 20-4 mA Node, as shown in Figure 6, the alarm settings of the Node can be configured. The High Alarm Value and High Pre-Alarm Value are related to setting the alarm and pre-alarm for the maximum danger value for the Node, and the Low Alarm Value and Low Pre-Alarm Value are related to setting the alarm and pre-alarm for the minimum danger value for the Node.

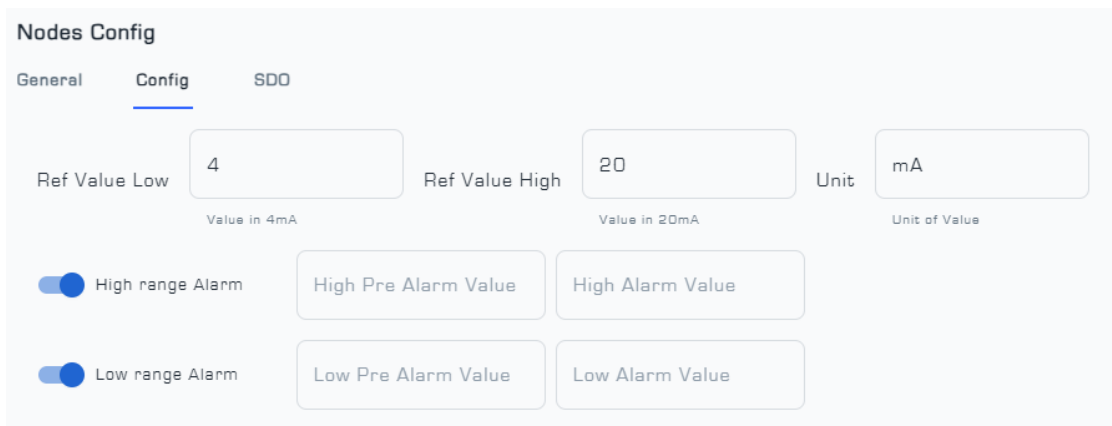

Figure 6: Config Menu from Node Config

- The SDO menu is used to change the parameters of Interval ¹ , Baud Rate ² , and Heartbeat³ (Figure 7).

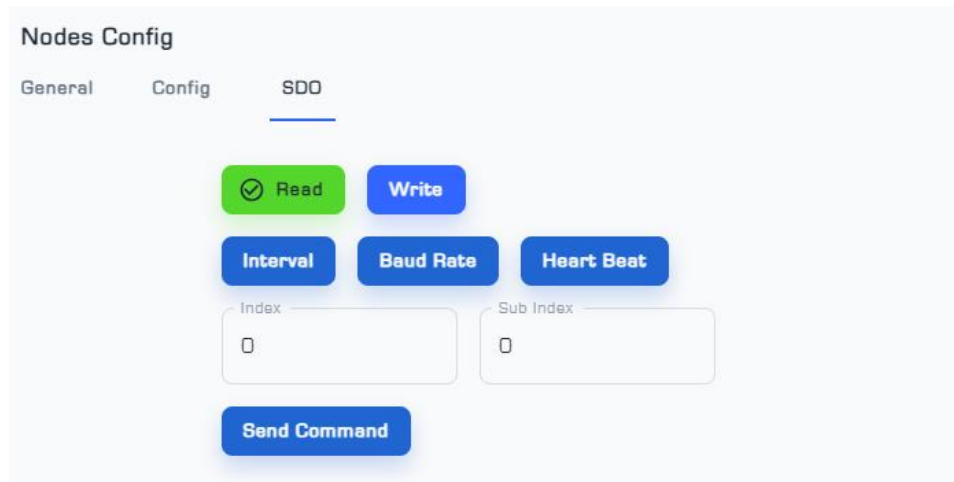

Figure 7: SDO Menu from Nodes Config page

- To read any of the Interval, Baud Rate, and Heartbeat parameters:
 - 1) Click on the Read option.
 - 2) Select the desired parameter.
 - 3) By selecting the Send Command option, you can view the information related to that parameter.
- To change any of the Interval, Baud Rate, and Heartbeat parameters:
 - 1) Click on the Write option.
 - 2) Select the desired parameter.
 - 3) Enter the desired value in the Data field.
 - 4) By selecting the Send Command option, the information related to that parameter will be saved. Note: The baud rate of the card and the Node must be the same. Refer to Table 3 for the exact value.

1. Data transmission interval (in milliseconds)

2. Data transmission rate

3. Node health status

- There are two ways to change the Baud Rate value:

Method 1: Connect each Node to the card individually and change its Baud Rate. After finishing the Nodes, set the Baud Rate of the card to the same value as the Node.

Method 2:

- 1) First, change the Baud Rate of the first Node and then change the Baud Rate of the card and disconnect the Node from the card.
- 2) Return the card's Baud Rate to its initial state.
- 3) Connect the next Node to the card and change its Baud Rate.
- 4) Change the card's Baud Rate to the value set for the Node.

The second method is more efficient because it allows testing after changing the Baud Rate of the card and Node.

Note: If the Node is offline, first test the network cable or RJ45 connection and, if you are sure that the cable connection is correct, reset the Node. To do this, unplug the network cable or RJ45 from the Node. Press and hold the FUNC key, then connect the network cable and hold the FUNC key until the ELFI light turns off, then release it.

Table 3: Baud Rate Selecting Guide

Wire Length						Nodes
500 Meters	250 Meters	100 Meters	40 Meters	20 Meters		
20 kbps	20 kbps	20 kbps 50 kbps 125 kbps	20 kbps 50 kbps 125 kbps 250 kbps	20 kbps 50 kbps 125 kbps 250 kbps 500 kbps	64	
10 kbps 20 kbps	10 kbps 20 kbps	20 kbps 50 kbps 125 kbps	20 kbps 50 kbps 125 kbps 250 kbps	20 kbps 50 kbps 125 kbps 250 kbps 500 kbps	32	
10 kbps 20 kbps	10 kbps 20 kbps	10 kbps 20 kbps 50 kbps 125 kbps	20 kbps 50 kbps 125 kbps 250 kbps	20 kbps 50 kbps 125 kbps 250 kbps 500 kbps	16	
10 kbps 20 kbps	10 kbps 20 kbps	10 kbps 20 kbps 50 kbps 125 kbps	20 kbps 50 kbps 125 kbps 250 kbps	20 kbps 50 kbps 125 kbps 250 kbps 500 kbps	8	
10 kbps 20 kbps	10 kbps 20 kbps	10 kbps 20 kbps 50 kbps 125 kbps	20 kbps 50 kbps 125 kbps 250 kbps	20 kbps 50 kbps 125 kbps 250 kbps 500 kbps	2	

Note: The information in this table is compatible with all Nodes that can be connected to the FIDAQUIRE data logger CANopen card.

5. Node Dimension

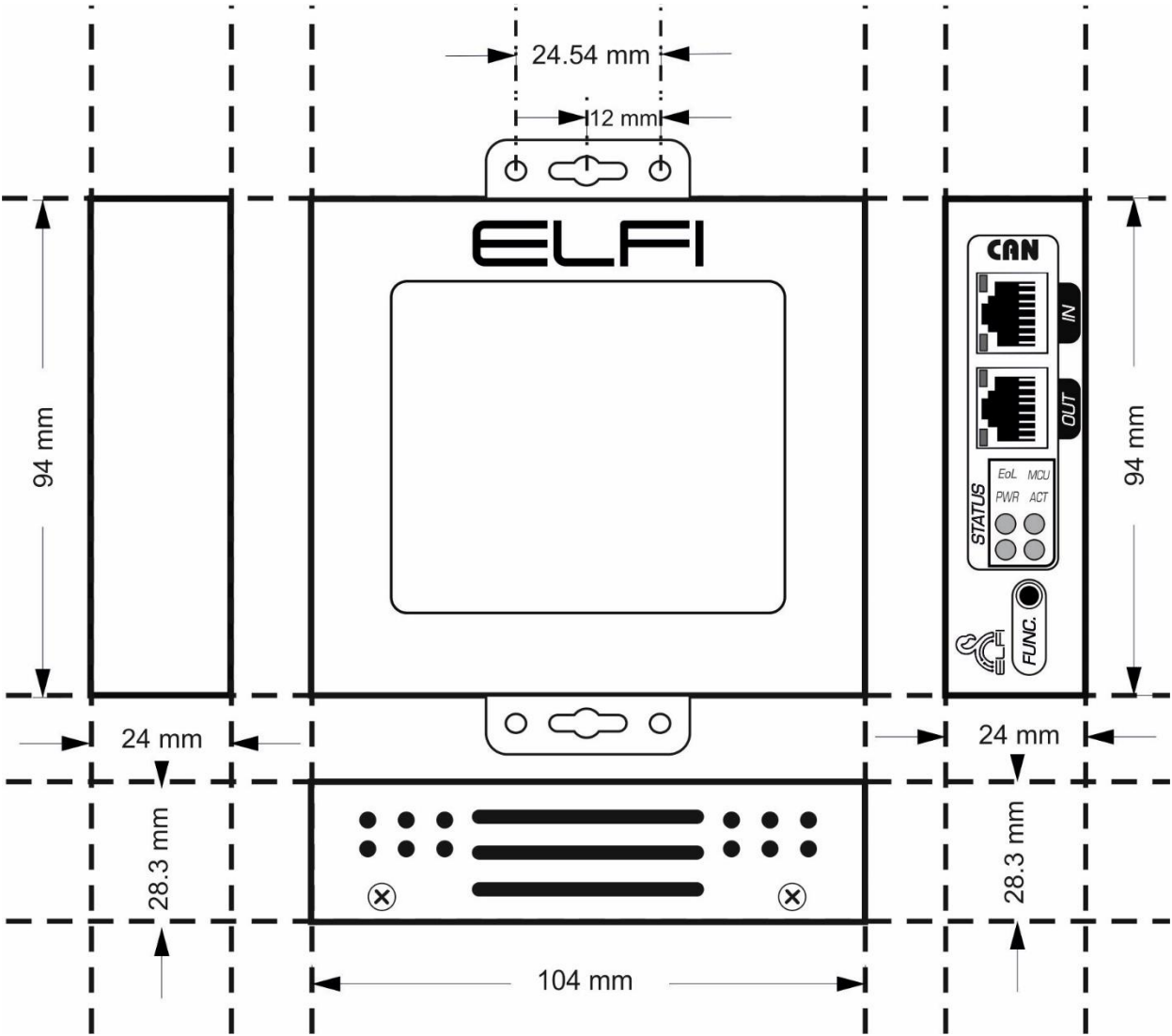

Contact us

Behineh Farayand Electronic Fidar Company

Telephone: +9802191308515

Address: West Azerbaijan Province, Urmia, 10th KM Sero Road, Science and Technology Park

Email: info@fidarelectronics.com

Website: www.fidarelectronics.com