



User Manual for Wireless 3-Channel DC Voltage Detector Node Model FAV0220-16

Description – Initialization – Technical Information



Node Technical Information

General	
Model	FAV0220-16
Dimension	Length × Height × Depth 10.4 cm × 2.4 cm × 9.4 cm
Weight	300 g
Working Temperature	-10 to 45 °C
Storage Temperature	-20 to 60 °C
Working Humidity	0 – 60%
Working Voltage	24 Volts
Mounting Brackets	2 holes at the top to be fixed on the wall
Guaranty	2 Years
Input/ Output	
Minimum Data Transmission Interval	500 ms
Type of Input	0–60-volt DC Voltage
Number of inputs	3
Output	Radio signal

Security Considerations

Before using this product, please read the precautions

Please carefully read this manual before using the product and pay full attention to the mentioned points to use the product correctly.

In this manual, safety measures are classified into two levels: “Warning  ” and “Caution  ”.

Warning 	Improper handling may lead to dangerous conditions and cause death or serious injury.
---	---

Caution 	Improper handling may lead to dangerous conditions and cause minor or moderate injury to persons or damage to property.
---	---

Follow the safety measures of both levels as they are very important for personal and system safety. Ensure that users read this manual and then keep it in a safe place for future reference.

Installation Precautions

Caution

- Ensure a secure connection between the antenna and the Node. If the connection is not established, the Node will not function properly.
- Use the Wireless 3-Channel DC Voltage Detector Node in an environment that complies with the general specifications in this manual. Using this Node in any other operational environment may cause electric shock, fire, malfunction, or damage and reduce the quality of the module.
- Never directly touch the conductive part or electronic component of the Wireless 3-Channel DC Voltage Detector Node. Doing so may cause malfunction or damage to the data logger.
- When installing the Wireless 3-Channel DC Voltage Detector Node on the wall, carefully tighten the wall screws. Loose screws may cause the Node to fall and create a short circuit.
- Prevent foreign materials such as dust or wire fragments from entering the Node. These foreign materials may cause fire, malfunction, or damage.

- Do not disconnect and reconnect the Node while the FIDAQUIRE data logger is on. Doing so will damage the Node and the FIDAQUIRE data logger.

Setup and maintenance precautions

Warning

- Do not touch the conductive or electronic parts of the Node during activation. Doing so may result in electric shock or damage to the Node.
-

Caution

- Installation and setup of the Node should be performed by experienced technicians with knowledge of electrical shock protection.
- Avoid resetting the Node unless absolutely necessary. Resetting the Node will restore the Interval, Spread Factor, and Channel parameters to their factory settings. These values are 5 seconds, 7, and 433 MHz, respectively.
- Avoid deleting the Node unless it is absolutely necessary, as this will erase all stored data.

Operational safety measures

Warning

- Do not touch any conductive parts or electronic components of the data logger while the Node is transmitting data. Doing so may cause the Node to malfunction or fail.
-

Caution

- To avoid noise interference, keep all radio communication devices, including mobile phones, at least 25 centimeters away from the Node in all directions.
- Under no circumstances should the Node be reset while data is being transmitted.

Waste disposal precautions

Caution

- Dispose the node as an industrial waste.
- Ensure Nodes are segregated from other waste in accordance with local regulations. Dispose of Nodes correctly at your local waste collection/recycling facility.

Contents of the box

Please verify that the box contents match the packing list. The following items should be included:

- A Wireless 3-Channel DC Voltage Detector Node, model FAV0220-16 ¹
- 3 input sockets
- 12-volt adaptor
- A user manual.

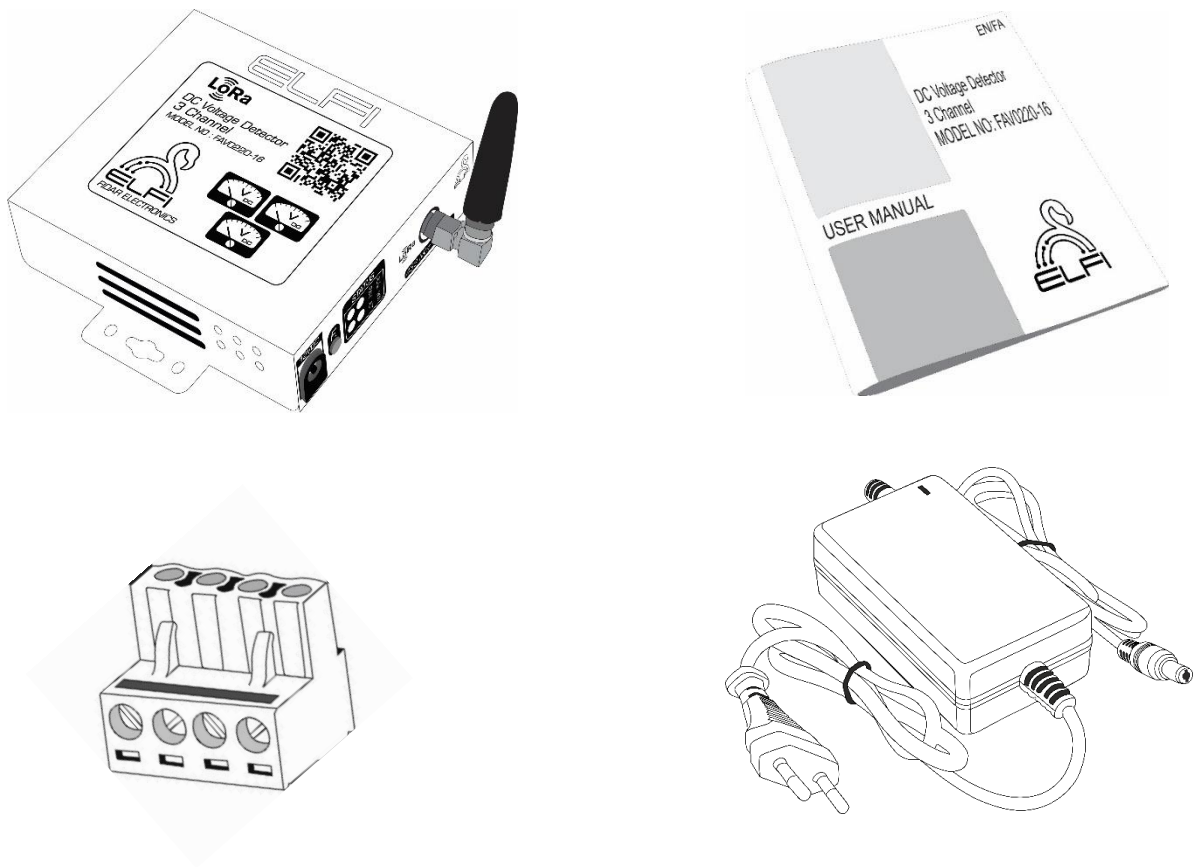

Figure 1: Contents of the box

1. Detailed dimensions of the device can be found on page 16 of the user manual.

Table of Contents

1. Initialization of the Node.....	8
2. Connecting Node to LoRa Card	10
3. Settings related to Node Software	11
4. Node Dimension	16
Contact us	17

1. Initialization of the Node

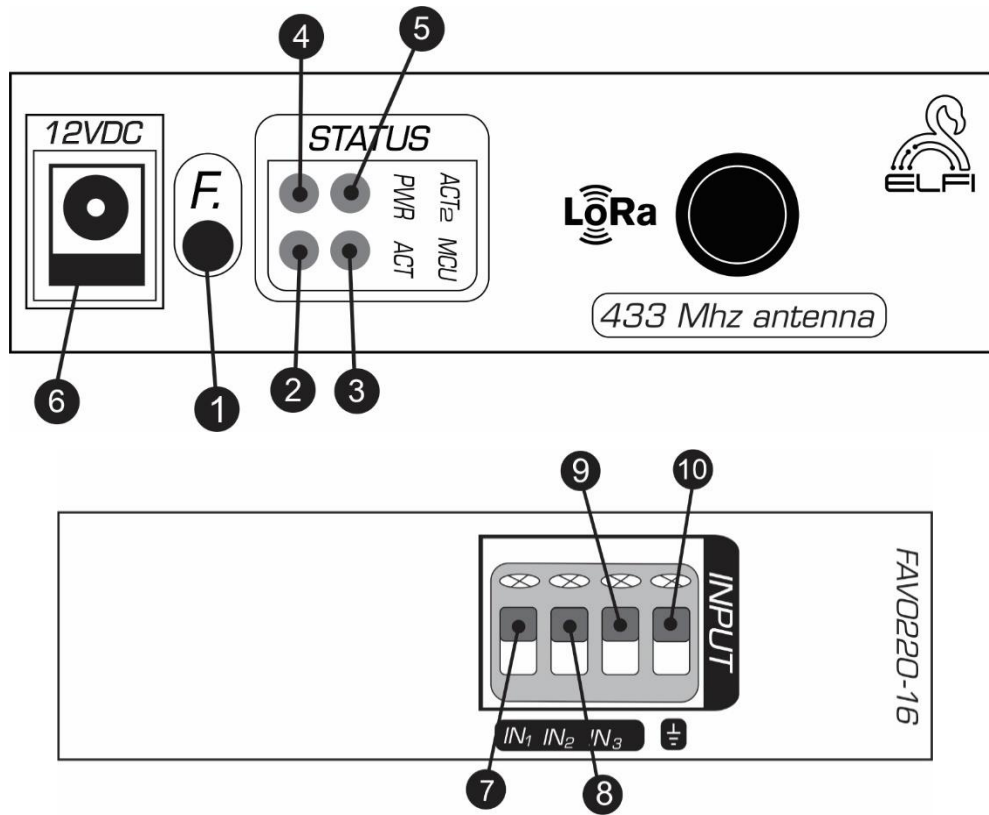

Figure 2: Side view of a Wireless 3-Channel DC Voltage Detector Node

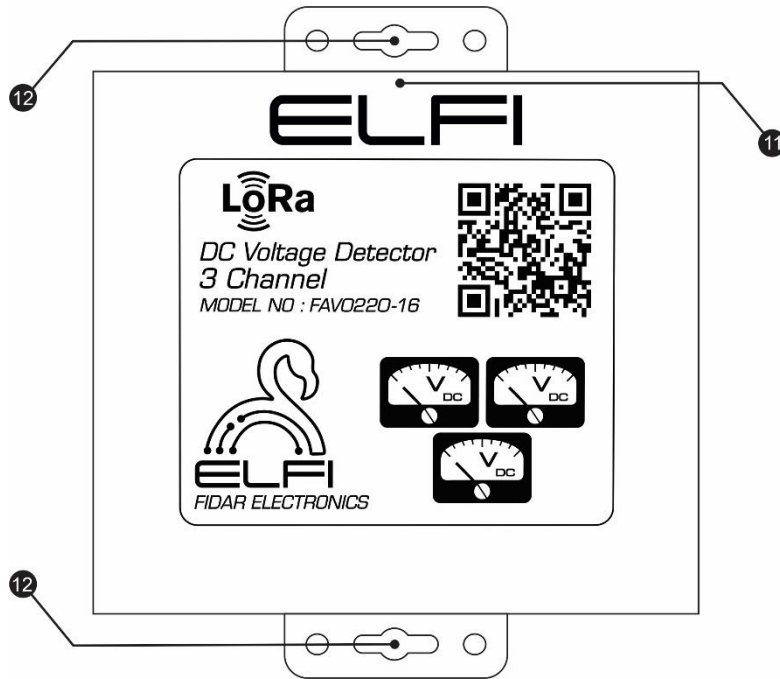

Figure 3: Front view of a Wireless 3-Channel DC Voltage Detector Node

Table 1: Information related to Node cover

Number	Name	Description
1	F Key	To perform a calibration and factory Reset ¹ procedure on the node
2	ACT LED	It relates to the system configuration
3	MCU LED	Broadcast transmission state from the card to the Node
4	POWER LED	Indicates Node's Power Connection
5	ACT 2 LED	Refers to System Configuration.
6	Node power supply Input	_____
7	1st Channel Input	_____
8	2nd Channel Input	_____
9	3rd Channel Input	_____
10	Ground	_____
11	Node Power Connection Display	If the Node's power is connected (on the LoRa bus), the ELFI symbol will be displayed in green.
12	Wall Mounting Location	_____

1. Factory reset

2. Connecting Node to LoRa Card

To pair the Node with the LoRa card, follow these steps:

- 1) Initially, press and hold the FUNC button on the LoRa card for three seconds. The LEDs on the top and bottom rows of the card will start to light up. This indicates that the card has entered pairing mode, and the LED corresponding to the first channel will turn on.
- 2) Connect the Node to power using the power supply.
- 3) Put the Node into pairing mode by pressing the F button twice in succession and holding it down for the third time until the MCU light blinks.
- 4) Select the desired channel on the card, and then press the FUNC button once to pair the Node and the card.
- 5) Finally, press and hold the FUNC button on the card for 5 seconds to exit pairing mode and enter operational mode.

Once the above steps are completed, the ACT light on the Node will start blinking. This indicates that the pairing process was successful and the Node will be displayed in the system.

Note: If you want to pair the Node to subsequent channels on the card, in step 4, after the LED corresponding to the first channel turns on, press the FUNC button twice in succession to move to the next channel and the corresponding LED will light up.

3. Settings related to Node Software

To identify and initially activate the Node, after connecting the Node to the FIDAQUIRE LoRa card datalogger, first enable the Active mode in the Node settings menu and then select the Initialize option (Figure 4).



Figure 4: How to Initially Activate a Node

After the successful activation of the Node, the sensor information, as shown in Figure 5, will be displayed on the card's screen. An output of zero indicates the presence of electric current, while an output of one indicates the absence of electric current.



Figure 5: Visualization of AC voltage detector Node on card display

To apply the settings to the Node, click on it to display the Node settings page (Nodes Config) (Figure 6).

- The General menu includes information about the Node status, model, serial number, input data type, and Node number. You can also choose a custom name for the Node and even deactivate it if necessary (Figure 6).

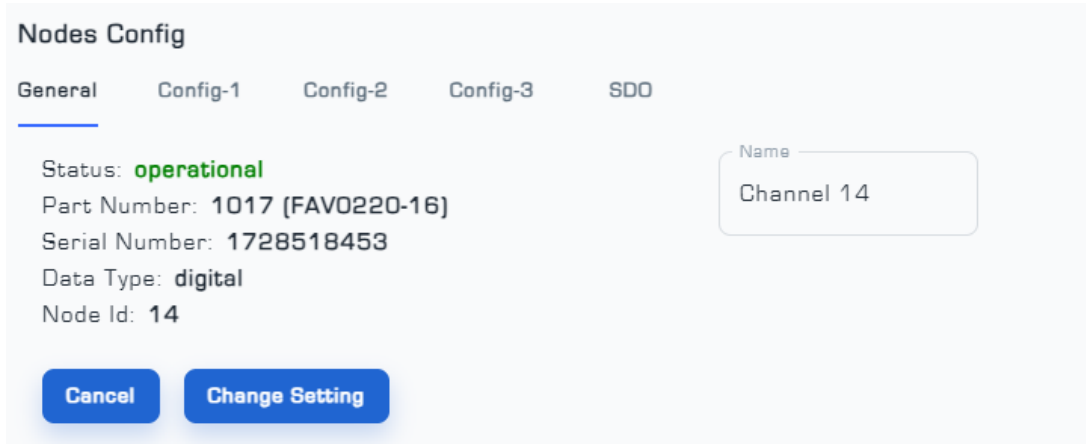

Figure 6: General Menu from Nodes Setting Page

Note: Table 2 shows all possible Node status states

Figure 2: All Possible Node Status States

Status	Description
Offline	Power disconnected
Operational	Node is sending data

To remove a Node from the LoRa card, first unplug the network cable from the Node to make it Offline. Then, in the General menu, select the “Remove” Node option.

Note: Please note that if the Node is completely removed from the card, its saved data will be completely deleted.

- The SDO menu is used to change the parameters of Interval¹, Spread Factor, and Channel² (Figure 7).

1. Data transmission interval (in milliseconds)
 2. Frequency

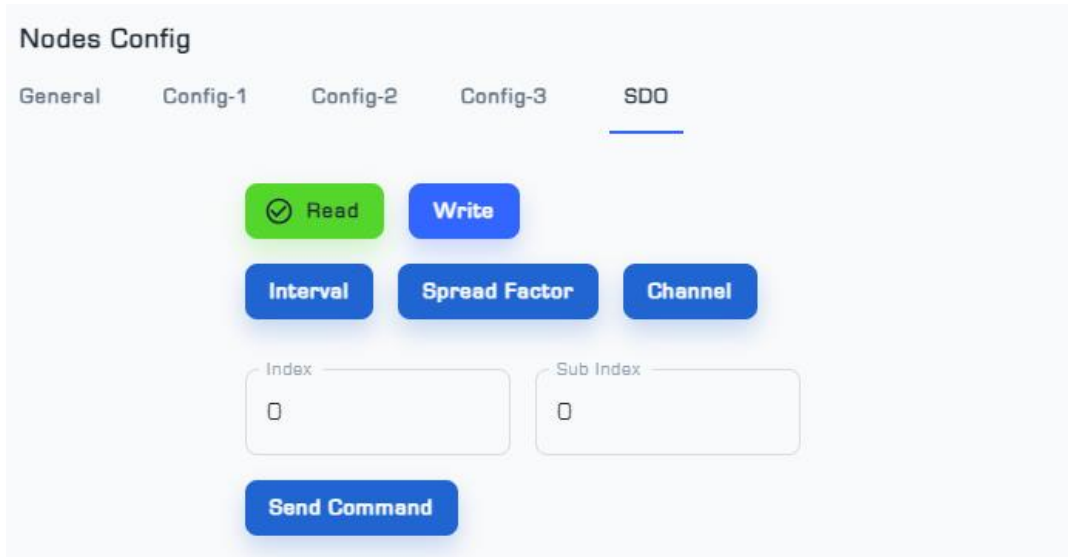

Figure 7: SDO Menu from Nodes Config page

- To read any of the Interval, Spread Factor, or Channel parameters:
 - (1) Click on the "Read" option.
 - (2) Select the desired parameter.
 - (3) By selecting the "Send Command" option, you can view the information related to that parameter.
- To change any of the Interval, Spread Factor, or Channel parameters:
 - (1) Click on the "Write" option.
 - (2) Select the desired parameter.
 - (3) Enter the desired value in the "Data" field.
 - (4) By selecting the "Send Command" option, the information related to that parameter will be saved.

Note: To reduce interference between devices and improve signal quality and operational efficiency, the Channel value can be changed from 425 MHz to 470 MHz.

Note: The Spread Factor value is set based on the distance between the Node and the data logger, ranging from 7 to 12. As the distance between the Node increases, the Spread Factor value should also increase. In other words, there is no standardized solution for the Spread Factor value, and its correct value is determined through trial and error.

Note: After finalizing the Spread Factor and Channel values, the Interval value is obtained from Table 3.

Note: The Spread Factor and Channel values of the card and Node must be the same. To set these two parameters, there are two methods:

Method 1:

Connect each Node to the card separately and change the parameter values through the SDO menu. After completing the Nodes, set the Spread Factor and Channel of the card to the same value as the Node.

Method 2:

- (1) First, change the Spread Factor and Channel of the first Node and then the card, and disconnect the Node from the card.
- (2) Return both card parameters to their initial state.
- (3) Connect the next Node to the card and change its Spread Factor and Channel.
- (4) Change the Spread Factor and Channel of the card to the value set for the Node.

Method 2 is more efficient because it allows testing after changing all three parameters of the card and Node.

Note: If the Node is offline, first test the power connection, and if the connection is correct, reset the Node. To do this, unplug the power from the Node. Press and hold the F key, then connect the power and hold the F key until the  light turns off, then release it.

Table 3: Guide for selecting the Interval value based on the number of Nodes and Spread Factor.

		Number of Nodes (Sensors)			
		1-4	5-8	9-12	13-16
Spread Factor Value	7	> 0.5s	> 1s	> 1.5s	> 2s
	8	> 1s	> 2s	> 3s	> 4s
	9	> 2s	> 4s	> 6s	> 8s
	10	> 4s	> 8s	> 12s	> 16s
	11	> 8s	> 16s	> 24	> 32s
	12	> 16s	> 32s	> 48	> 64s

Note: The information in this table is compatible with all Nodes that can be connected to the FIDAQUIRE data logger LoRa card.

4. Node Dimension

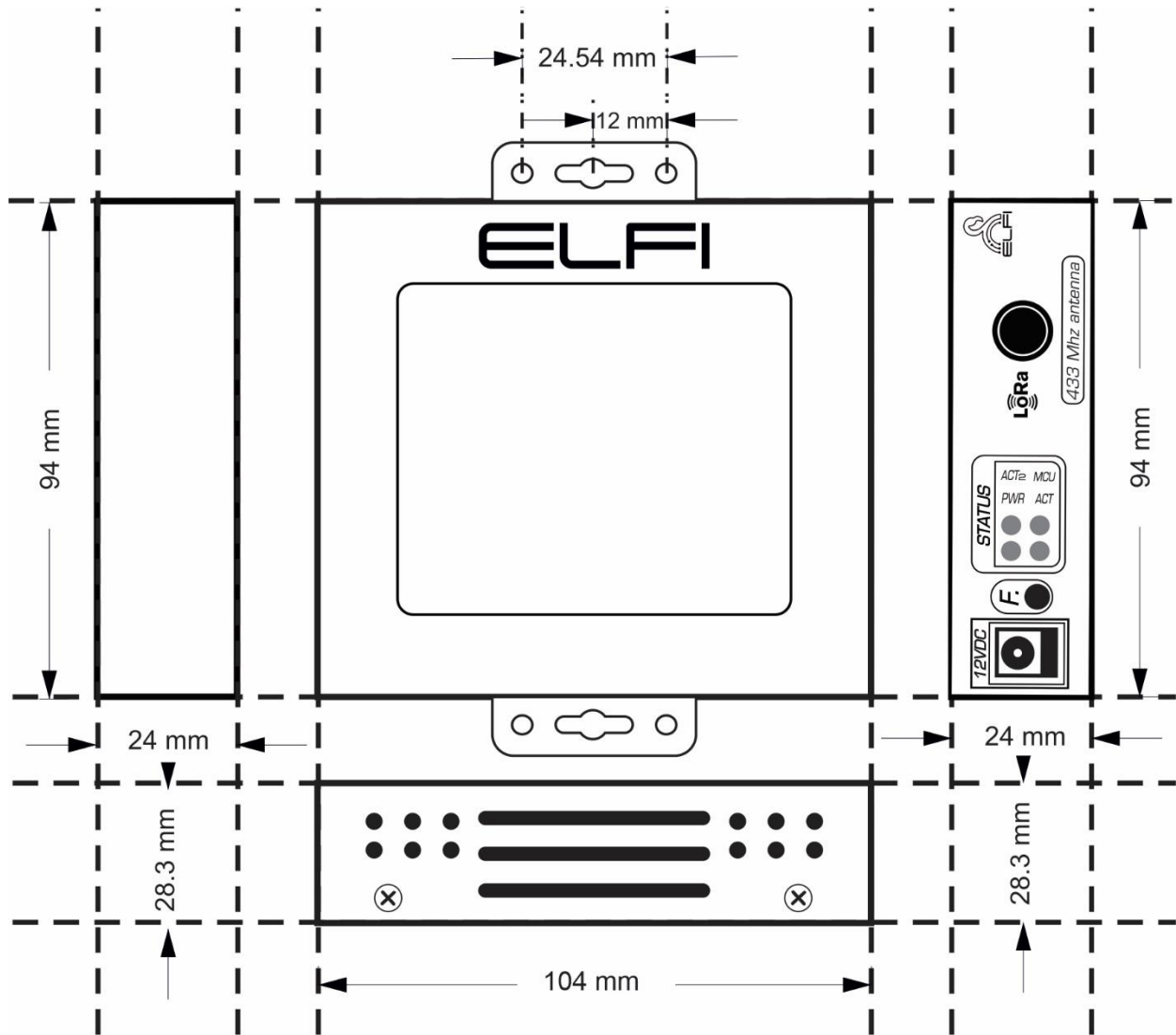

Contact us

Behineh Farayand Electronic Fidar Company

Telephone: +9802191308515

Address: West Azerbaijan Province, Urmia, 10th KM Sero Road, Science and Technology Park

Email: info@fidarelectronics.com

Website: www.fidarelectronics.com